

The Storage Daybed

Modeled after the Pottery Barn Stratton Daybed with Baskets (\$999)

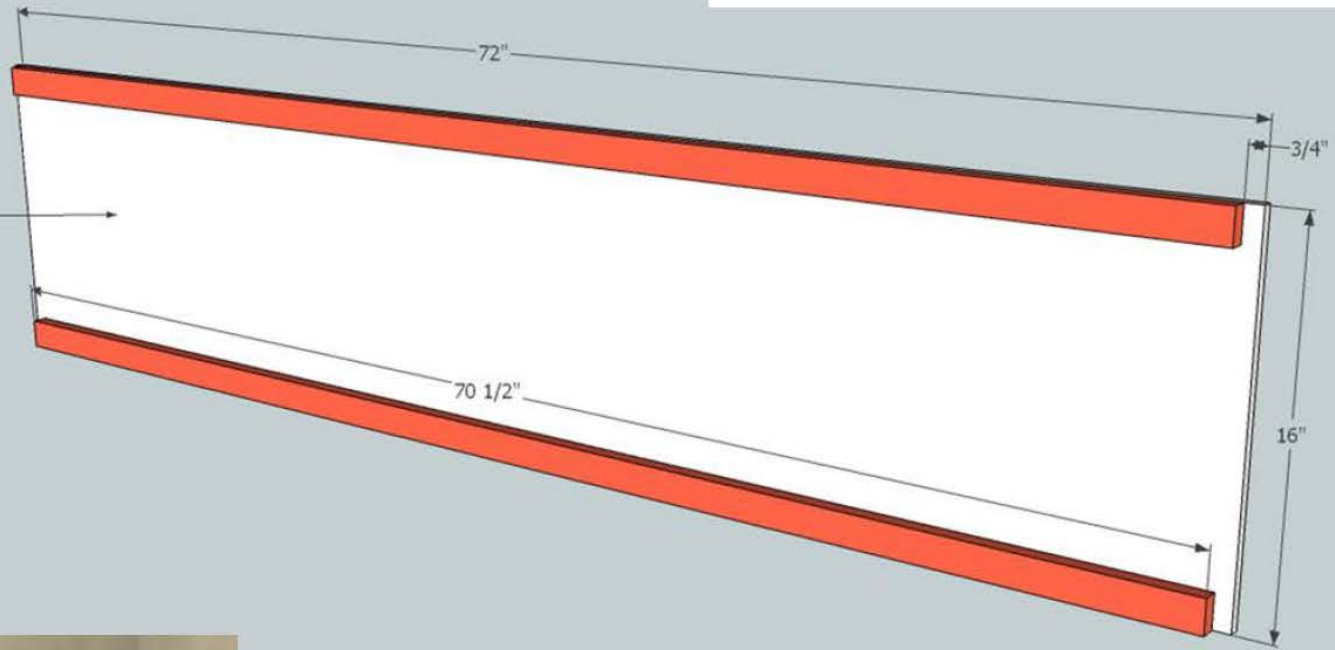

Glue and nail (2) 1x2 boards to the rough side of a 1/2" sheet of plywood using wood glue and 1" finishing nails.



Step 1

The Storage Daybed

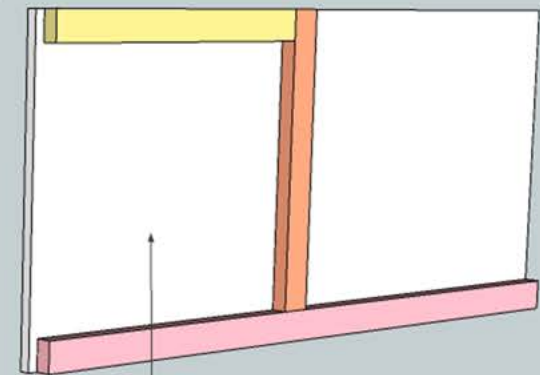
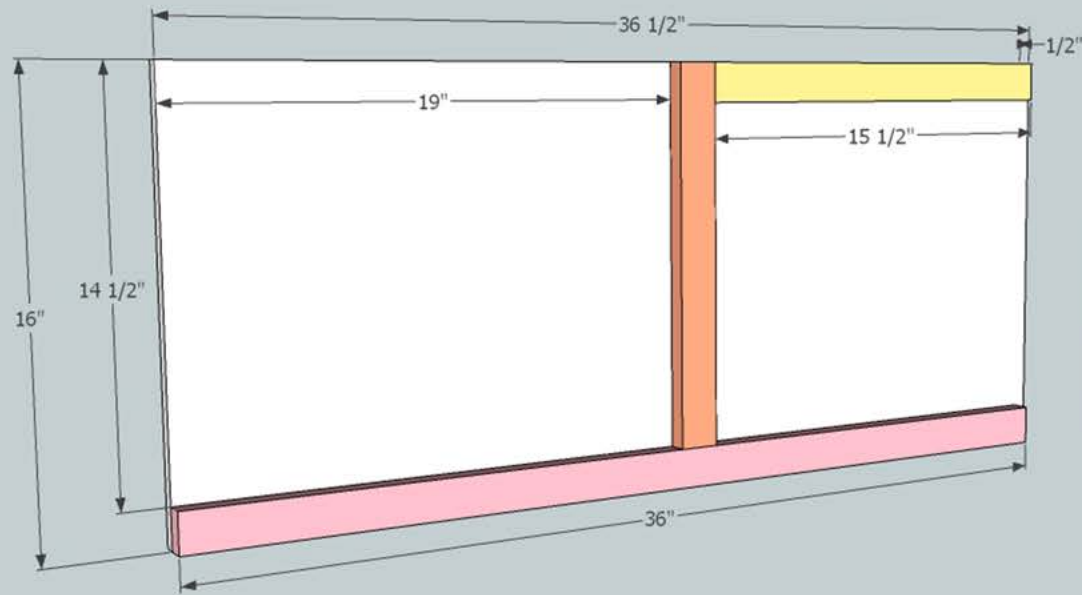

Fix a 36", 14 1/2" and a 15 1/2" 1x2 boards to the rough side of a 1/2" thick 16"x36 1/2" sheet of plywood as shown. Repeat but mirror the arrangement of 1x2 boards. These are your left and right sides of the daybed. Use wood glue and 1" finishing nails.

The Storage Daybed

Join the back and sides of the daybed together with wood glue and by nailing through the outside edges and back with 1 1/2" finishing nails.

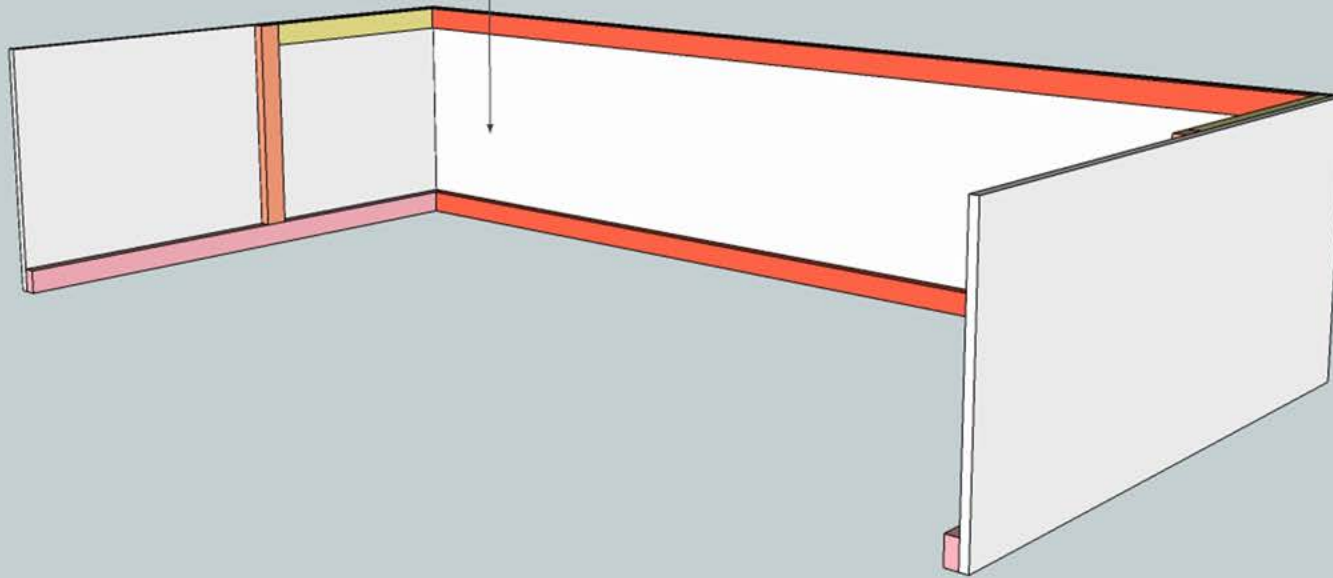

The Storage Daybed

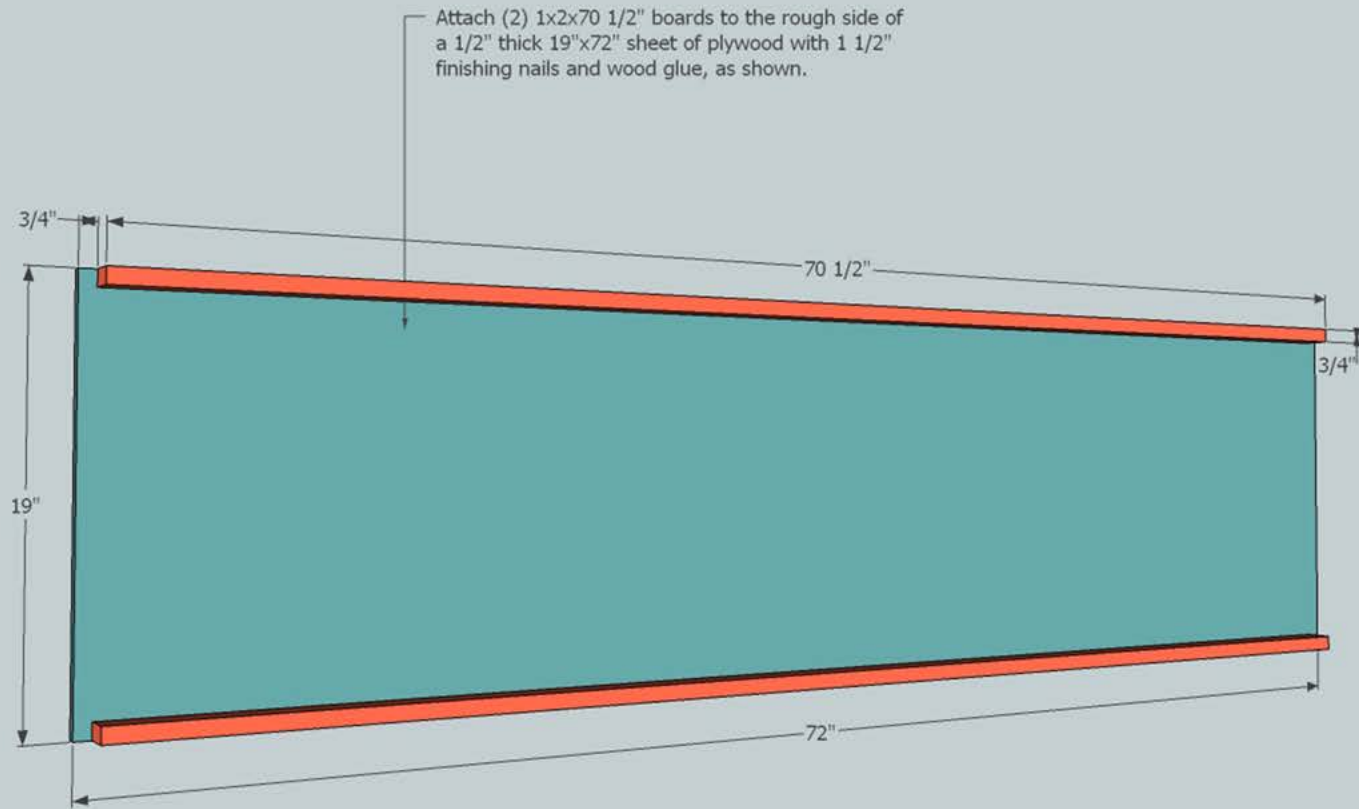

The Storage Daybed

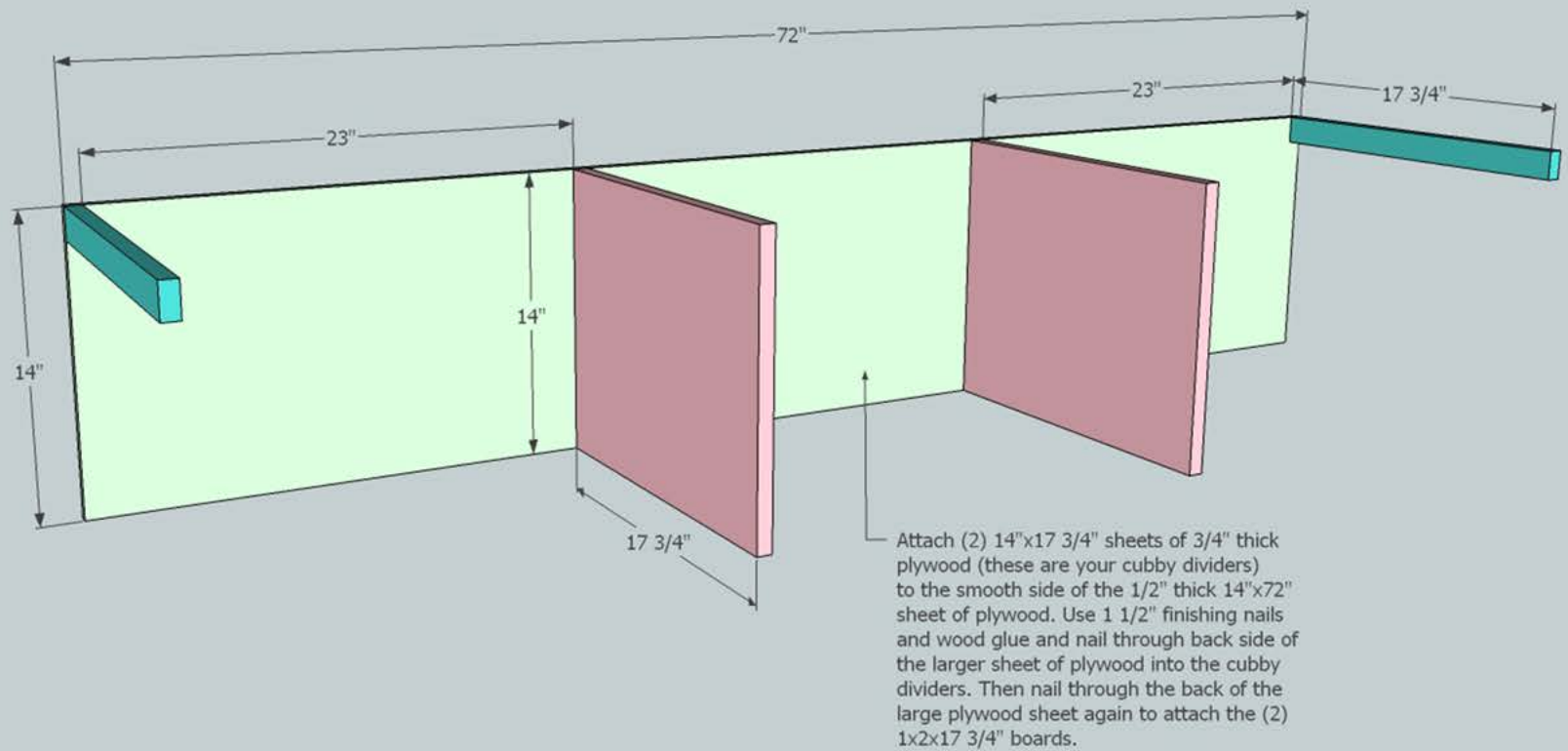

The Storage Daybed

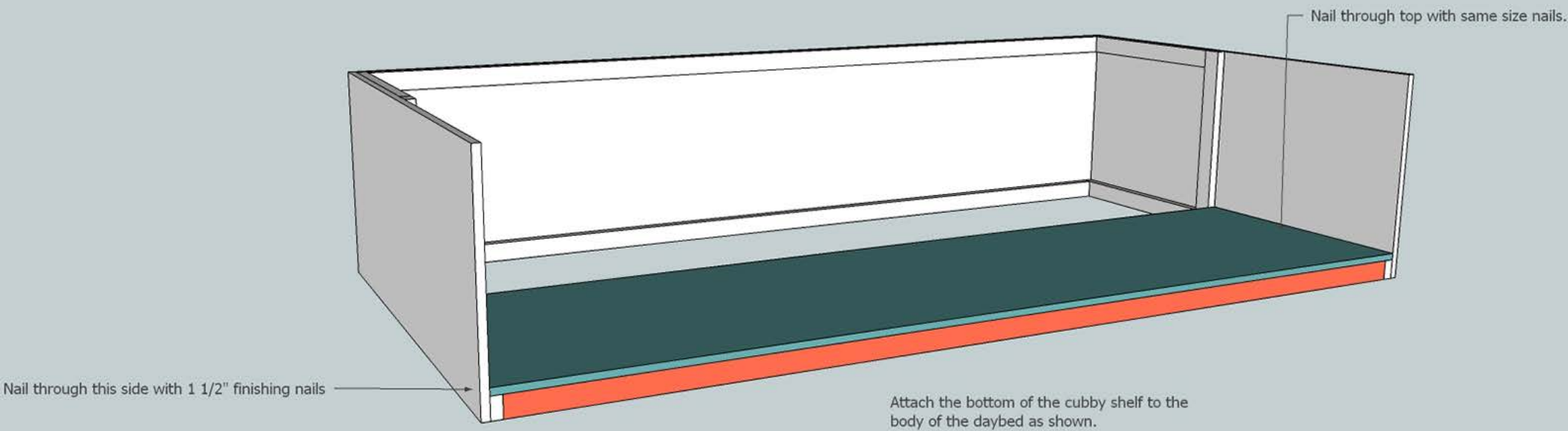

The Storage Daybed

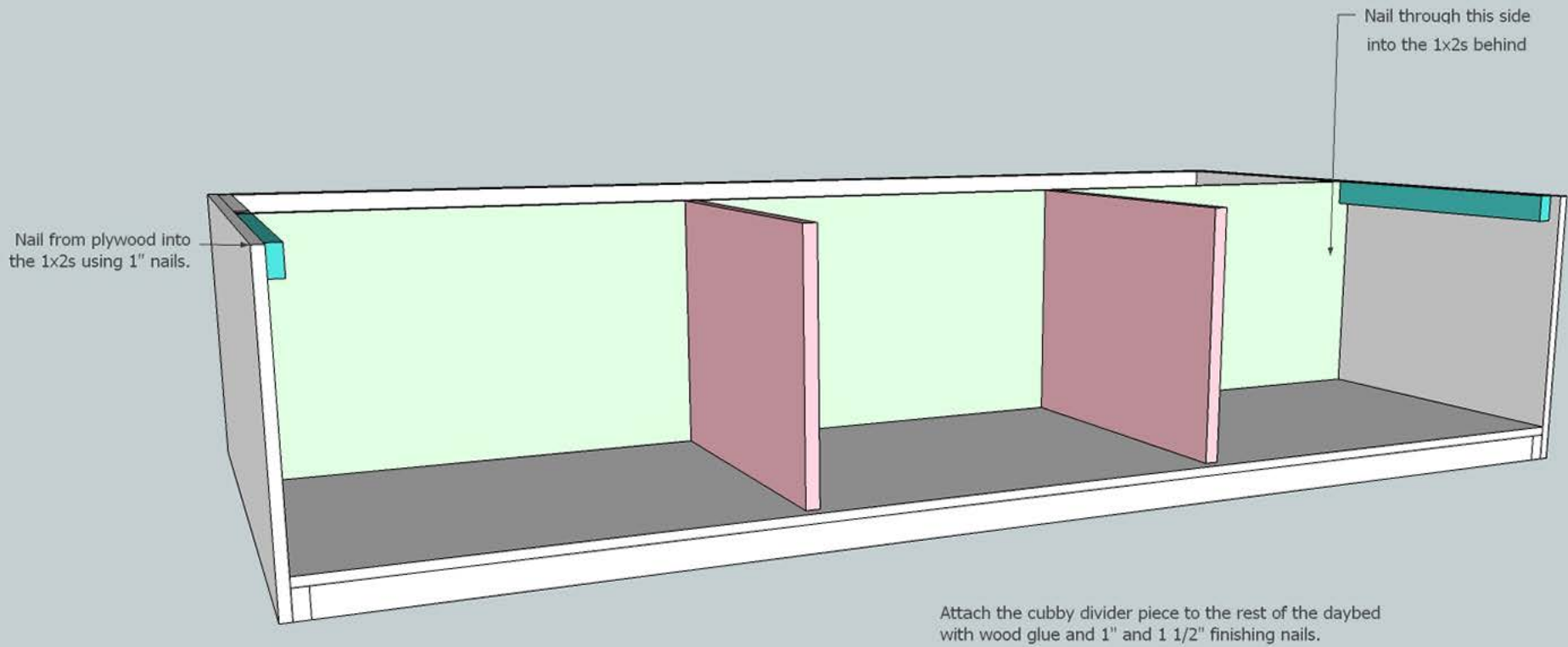

The Storage Daybed

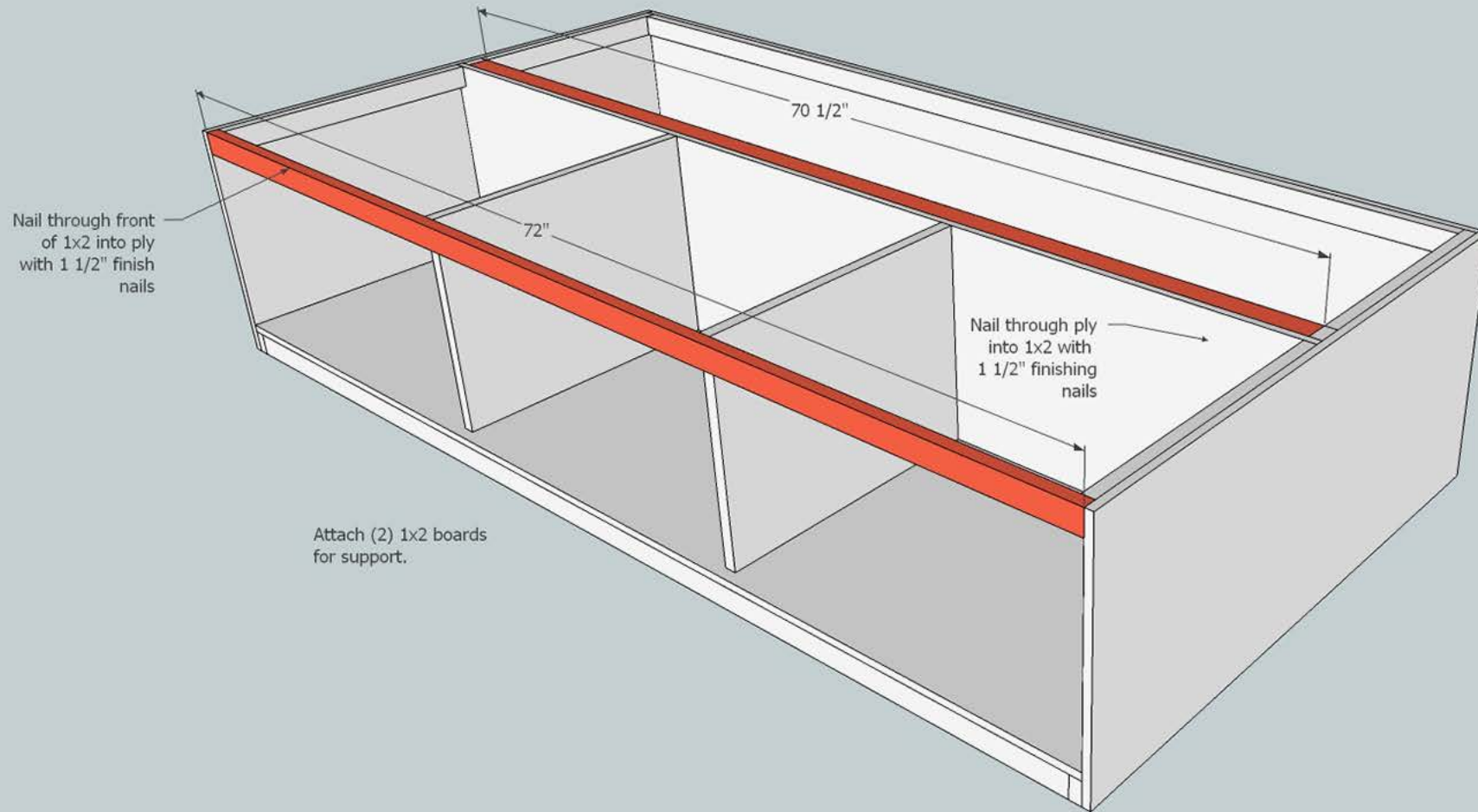

The Storage Daybed

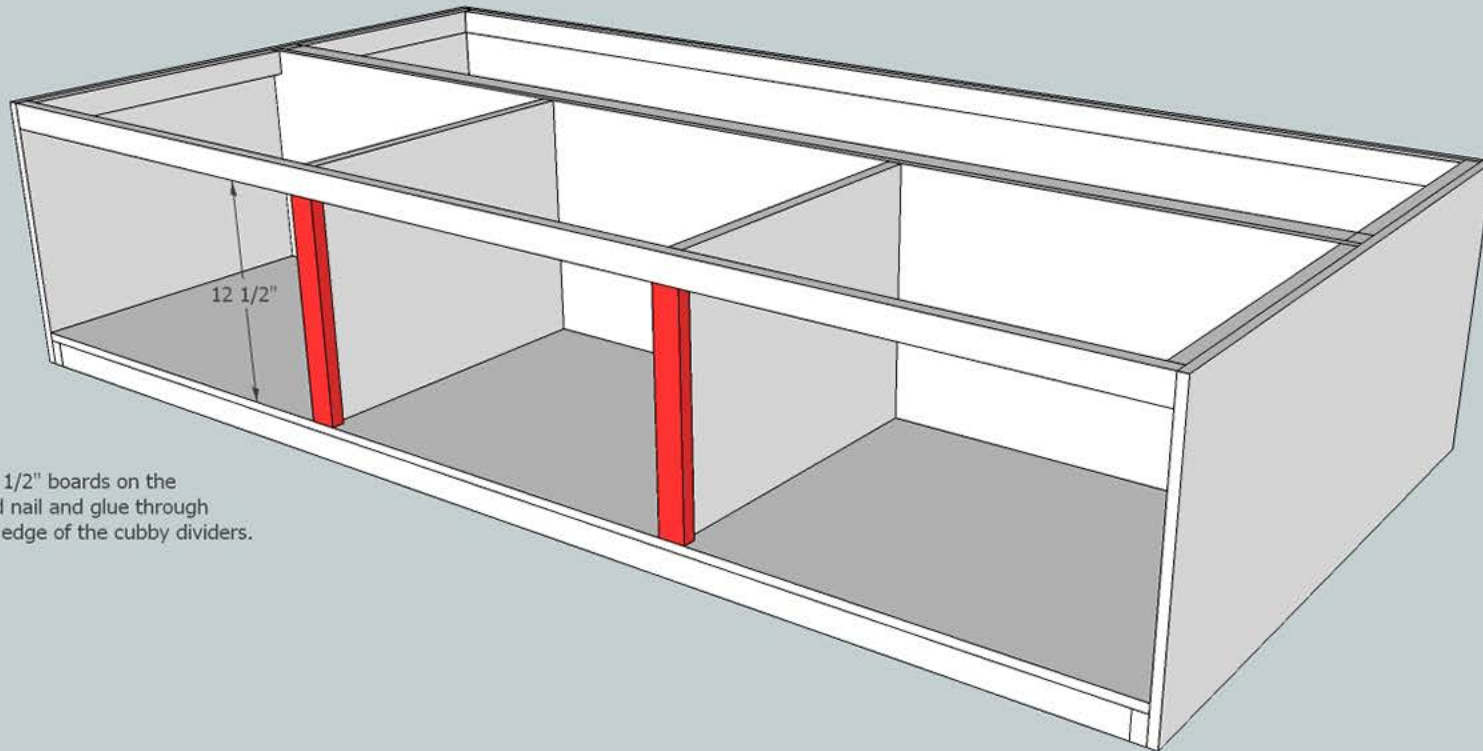

Center (2) 1x2x12 1/2" boards on the cubby dividers and nail and glue through the front onto the edge of the cubby dividers.

The Storage Daybed

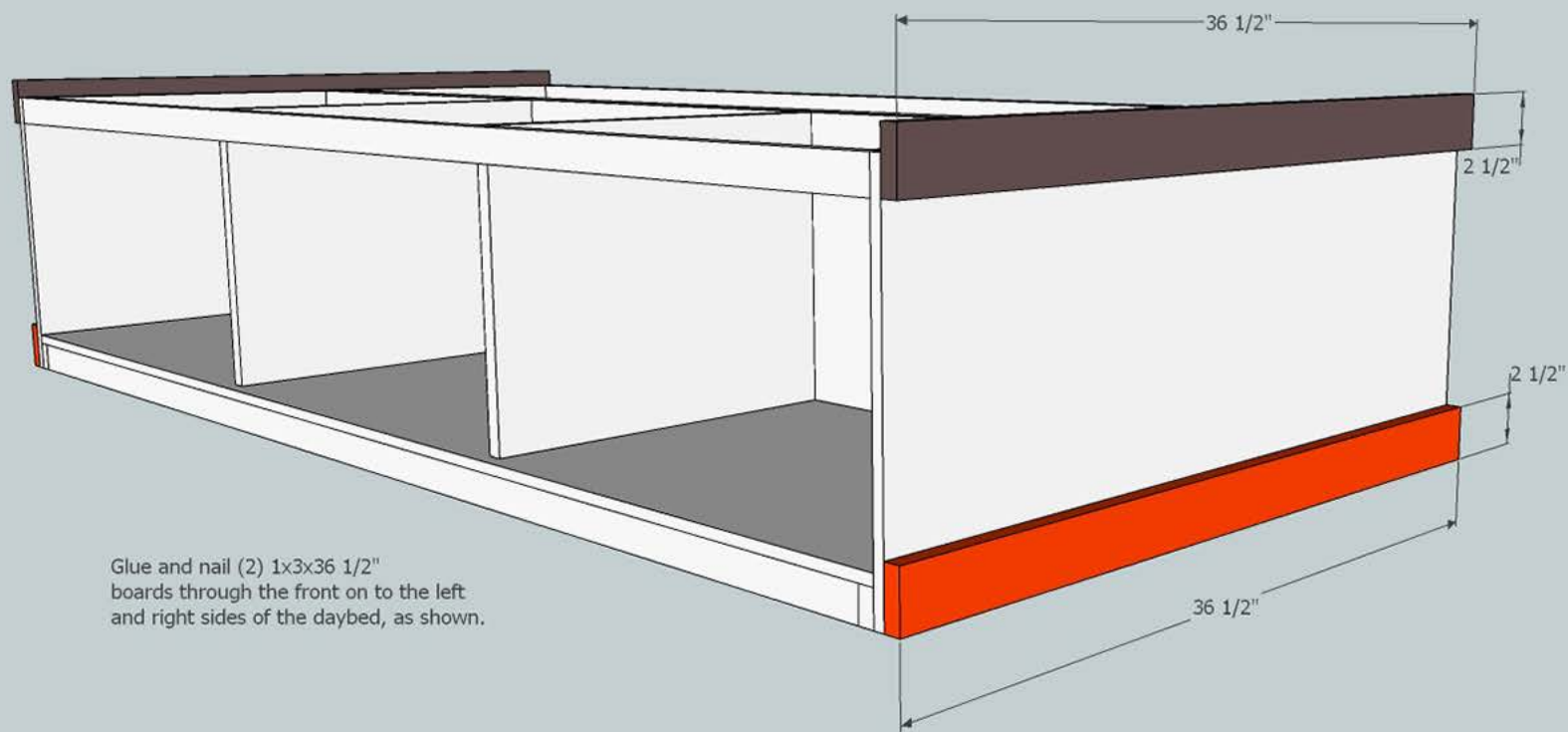

Glue and nail (2) 1x3x36 1/2" boards through the front on to the left and right sides of the daybed, as shown.

The Storage Daybed

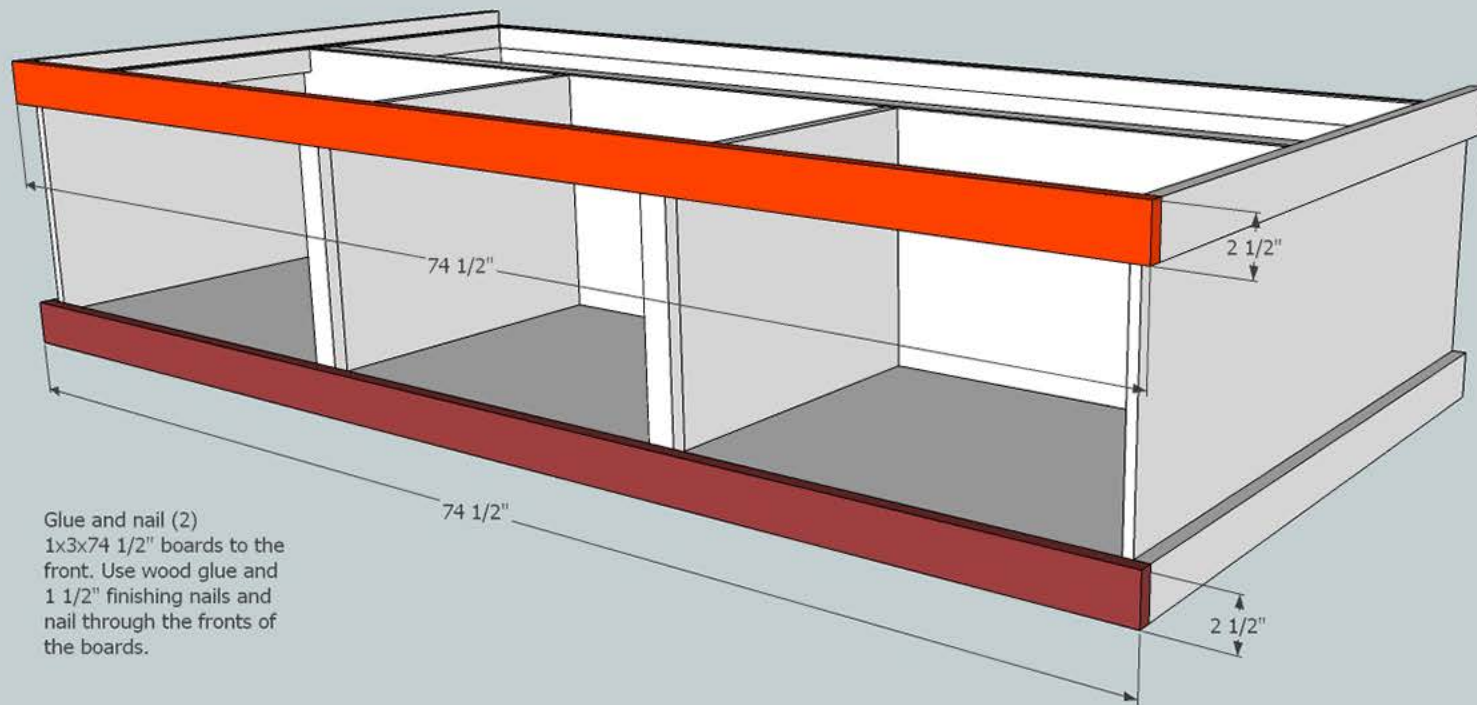

Glue and nail (2)
1x3x74 1/2" boards to the
front. Use wood glue and
1 1/2" finishing nails and
nail through the fronts of
the boards.

The Storage Daybed

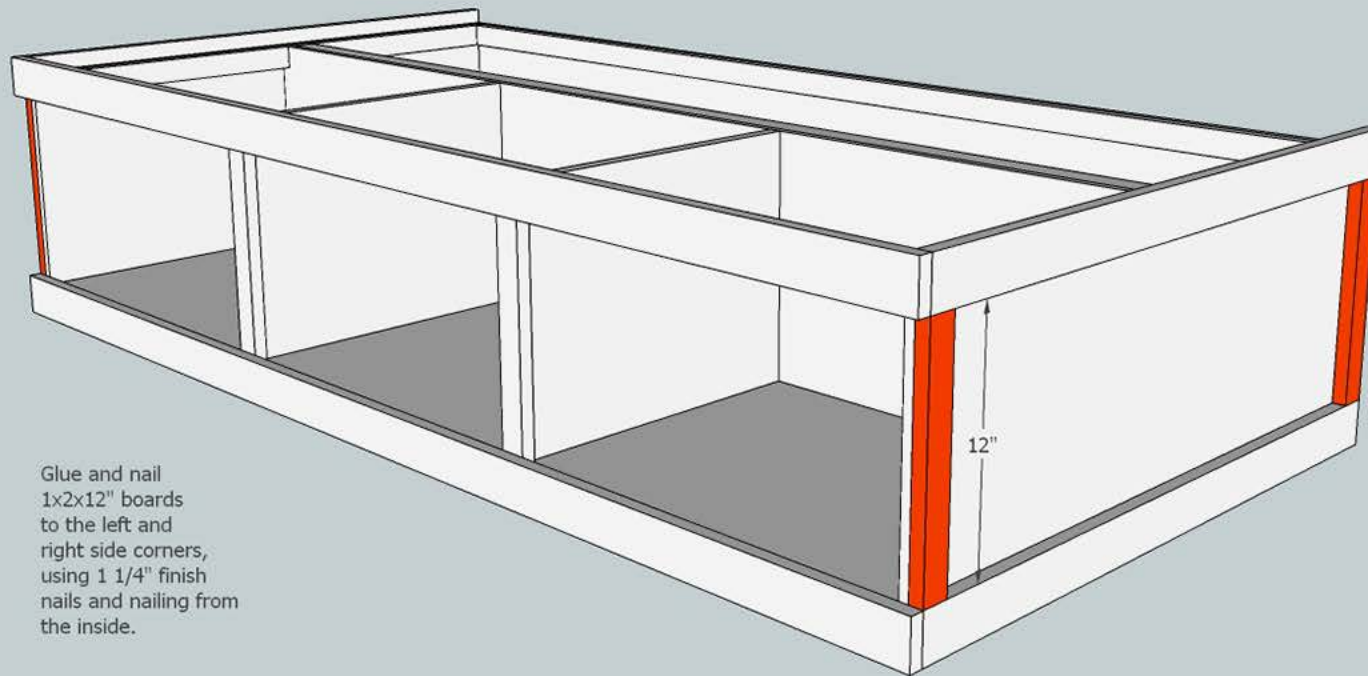

Glue and nail
1x2x12" boards
to the left and
right side corners,
using 1 1/4" finish
nails and nailing from
the inside.

The Storage Daybed

Nail and glue through front of boards to attach (2) 1x3x12" pieces to the front left and right of daybed. These are for extra support and style and should be attached with wood glue and 1 1/2" finish nails.

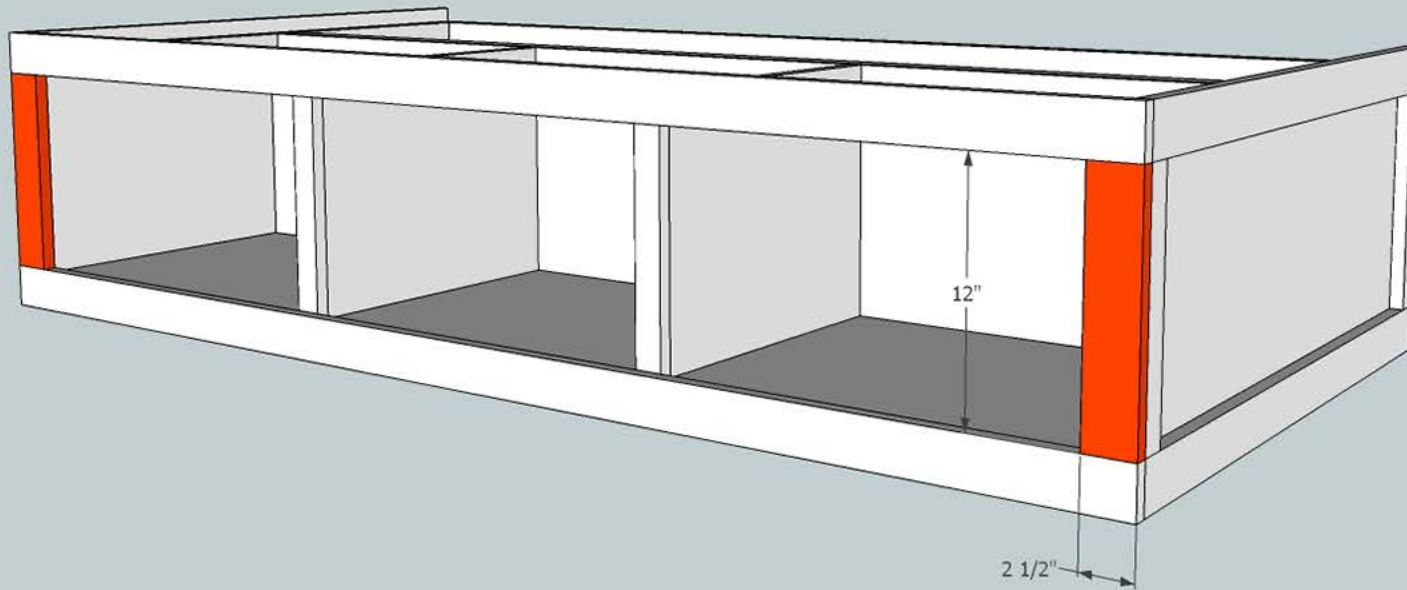

The Storage Daybed

Use wood glue and 1 1/2" finish nails to attach the 3/4" thick 36 1/2" x 73" sheet of plywood. This is the top and doubles as a boxspring so the thickness of the board is important for its strength!

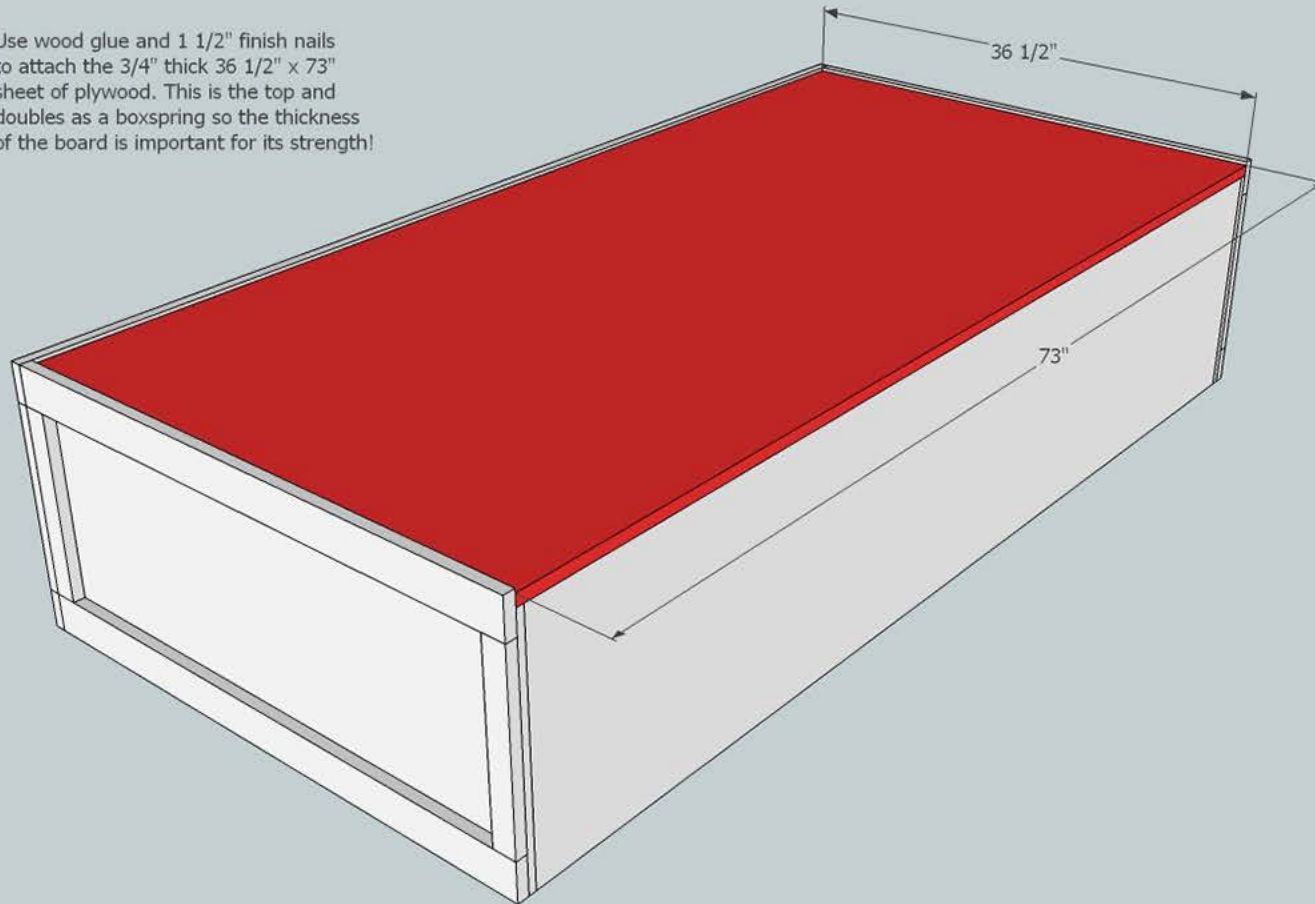







The Storage Daybed



The Complete Daybed!

The Storage Daybed

The Supply and Cost List

	1 x 2 x 8 Pine Board Model # 914185	\$4.25	<input type="text" value="1"/>	\$4.25
			+ ADD TO LIST	
			X REMOVE	
	1 x 2 x 8 #2 Ponderosa Pine Board Model # 914584	\$3.82	<input type="text" value="7"/>	\$26.74
			+ ADD TO LIST	
			X REMOVE	
	1 x 3 x 8 Select Pine Board Model # 914223	\$6.62	<input type="text" value="4"/>	\$26.48
			+ ADD TO LIST	
			X REMOVE	
	Project Panels 1/2 in. x 2 ft. x 4 ft. Sandeply Hardwood Plywood Model # 1511012	\$16.87	<input type="text" value="1"/>	\$16.87
			+ ADD TO LIST	
			X REMOVE	
	Project Panels Maple Plywood (Price Varies by Size) Model # 1826	\$17.65	<input type="text" value="1"/>	\$17.65
			+ ADD TO LIST	
			X REMOVE	
	12mm, (1/2 in), 4ft x 8ft, Sandeply Hardwood Plywood Model # 454532	\$37.97	<input type="text" value="1"/>	\$37.97
			+ ADD TO LIST	
			X REMOVE	
	3/4 in. x 4 ft. x 8 ft. HD Maple Plywood Model # 263012	\$40.97	<input type="text" value="1"/>	\$40.97
			+ ADD TO LIST	
			X REMOVE	
Estimated Subtotal				\$176.93

The Storage Daybed

1x2		1x3		3/4" Plywood		1/2" Plywood	
Quantity	Cut	Quantity	Cut	Quantity	Cut	Quantity	Cut
5	70.5"	4	36.5"	1	72"x16"	2	17.75"x14"
2	15.5"	2	74.5"	2	36.5"x16"	1	73"x36.5"
2	14.5"	2	12"	1	72"x19"		
2	36"			1	72"x14"		
2	17.75"						
1	72"						
2	12.5"						
4	12"						